

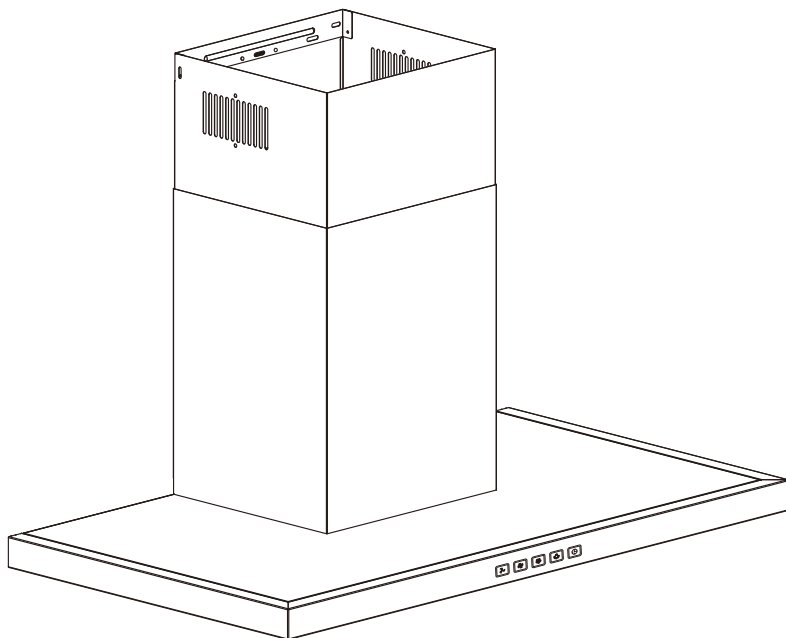

Range hood

Instruction Manual

Model : CS1-602ST
CS1-902ST



Content

1.....	Safety instructions
2.....	Installation
3.....	Start using your range hood
4.....	Troubleshooting
5.....	Maintenance and cleaning
6.....	Environment protection
11.....	Warranty Card

SAFETY INSTRUCTIONS

This manual explains the proper installation and use of your range hood, please read it carefully before using even if you are familiar with the product. The manual should be kept in a safe place for future reference.

Never to do:

- Do not try to use the range hood without the grease filters or if the filters are excessively greasy!
- Do not install above a range with a high level grill.
- Do not leave frying pans unattended during use because overheated fats or oils might catch fire.
- Never leave naked flames under the range hood.



- If the range hood is damaged, do not attempt to use.
- Do not flambe under the range hood.
- **CAUTION:** Accessible parts may become hot when used with cooking appliances.
- The minimum distance between the supporting surface for the cooking vessels on the hob and the lowest part of the range hood is 60cm. (When the range hood is located above a gas appliance, this distance shall be at least 75 cm)
- The air must not be discharged into a flue that is used for exhausting fumes from appliances burning gas or other fuels. Range hoods and other cooking fume extractors may adversely affect the safe operation of appliances burning gas or other fuels (including those in other rooms) due to back flow of combustion gases. These gases can potentially result in carbon

monoxide poisoning. After installation of a range hood or other cooking fume extractor, the operation of open flued gas appliances should be tested by a competent person to ensure that back flow of combustion gases does not occur.



Always to do

- **Important!** Always switch off the electricity supply at the mains during installation and maintenance such as light bulb replacement.
- The range hood must be installed in accordance with the installation instructions and all measurements followed.
- All installation work must be carried out by a competent person or qualified electrician.
- Please dispose of the packing material carefully. Children are vulnerable to it.
- Pay attention to the sharp edges inside the range hood especially during installation and cleaning.
- Make sure the ducting has no bends sharper than 90 degrees as this will

reduce the efficiency of the range hood.

- **Warning:** Failure to install the screws or fixing device in accordance with these instructions may result in electrical hazards.
- **Warning:** Before obtaining access to terminals, all supply circuits must be disconnected.
- If the voltage rating of the lamp is less than the rated voltage of the range hood, the voltage rating of the lamp shall also be marked on or near the lamp holder.

Always to do:

- Always put lids on pots and pans when cooking on a gas cooker.
- When in extraction mode, air in the room is being removed by the range hood. Please make sure that proper ventilation measures are being observed. The range hood removes odours from room but not steam.
- There shall be adequate ventilation of the room when the range hood is used at the same time as range hoods burning gas or other fuels.
- Range hood is for domestic use only.



- If the supply cord is damaged, it must be replaced by the manufacturer, its service agent or similarly qualified persons in order to avoid a hazard.
- This range hood is not intended for use by persons (including children) with reduced physical, sensory or mental capabilities, or lack of experience and knowledge, unless they have been given supervision or instruction concerning use of the range hood by a person responsible for their safety.

- Children should be supervised to ensure that they do not play with the range hood.
- This range hood can be used by children aged from 8 years and above and persons with reduced physical, sensory or mental capabilities or lack of experience and knowledge if they have been given supervision or instruction concerning use of the range hood in a safe way and understand the hazards involved. Children shall not play with the range hood. Cleaning and user maintenance shall not be made by children without supervision.



Always to do:

- **Caution:** The range hood and its accessible parts can become hot during operation. Be careful to avoid touching the heating elements. Children younger than 8 years old should stay away unless they are under permanent supervision.
- There is a fire risk if cleaning is not carried out in accordance with the instructions.
- Regulations concerning the discharge of air have to be fulfilled.
- Clean your range hood periodically by following the method given in the chapter MAINTENANCE.
- For safety reason, please use only the same size of fixing or mounting screw which are recommended in this instruction manual.
- Regarding the details about the method and frequency of cleaning, please refer to maintenance and

cleaning section in the instruction manual.

- Regarding the information about how the range hood is to be fixed to its support, please refer to Operation section, the installation procedures in this manual.
- Cleaning and user maintenance shall not be made by children without supervision.
- When the range hood and appliances supplied with energy other than

electricity are simultaneously in operation, the negative pressure in the room must not exceed 4 Pa (4×10^{-5} bar).

- **WARNING:** Danger of fire: Do not store items on the cooking surfaces.
- A steam cleaner is not to be used.
- **NEVER** try to extinguish a fire with water, but switch off the appliance and then cover flame e.g. with a lid or a fire blanket.

INSTALLATION

If you have an outlet to the outside, your range hood can be connected as below picture by means of an extraction duct (enamel, aluminum, flexible pipe or non-flammable material with an interior diameter of 80mm)

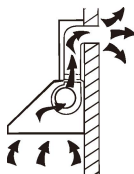

1. Before installation, turn the unit off and unplug it from the outlet.



2. The range hood should be placed at a distance of 60~75cm above the cooking surface for best effect.

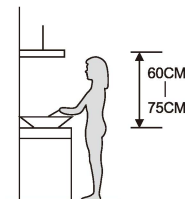

Pic 1

3. Install the hook on a suitable place once the installation height is fixed, and keep it in line. The fixed position of the inside chimney bracket is the highest place of chimney. See pic 2.

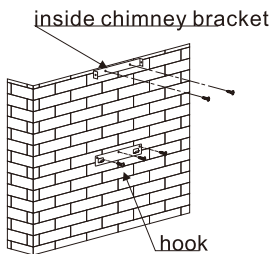

Pic 2

4. Fix the outside chimney bracket on the outside chimney, and be sure that the inside chimney can be adjusted the height in it freely as well as fixing the expansion pipe. Afterwards, install the expansion pipe and chimney on the range hood. Fix the expansion pipe with a cable tie on the outlet. See Pic 3/Pic4.

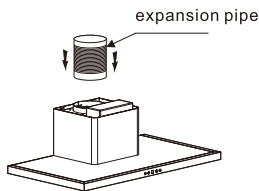

Pic 3

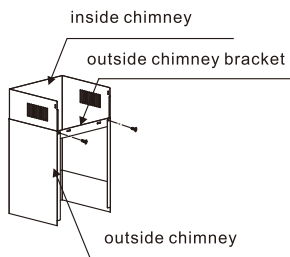
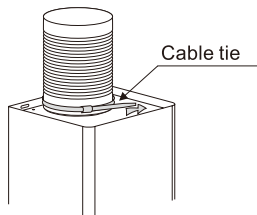

Pic 4

5. Put the range hood on the hook. Then adjusting the position and fix the body with safety screws. Note: The two safety vents are positioned on the back housing, with diameter of 6mm. See pic 5 & 6.
6. Adjust the height of the inside chimney to the position of the inside chimney bracket and fix it with screws. See pic 7.

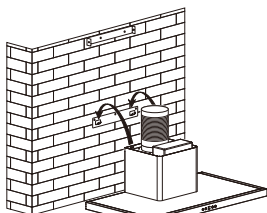

Pic 5

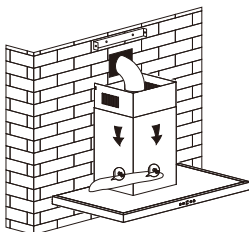

Pic 6

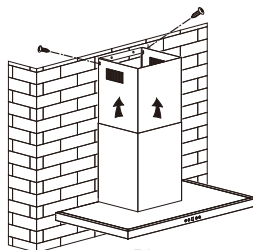

Pic 7

HINTS FOR EXHAUST DUCT INSTALLATION

The following rules must be strictly followed to obtain optimal air extraction:

- Keep expansion pipe short and straight.
- Do not reduce the size or restrict the expansion pipe.
- When using the expansion pipe always install the pipe pulled taut to minimize pressure loss.
- Failure to observe these basic instructions will reduce the performance and increase noise levels of the range hood.
- Any installation work must be carried out by a qualified electrician or competent person.
- Do not connect the ducting system of the hood to any existing ventilation system which is being used for any other appliance, such as warmer tube, gas tube, hot wind tube.
- The angle of the bend of the expansion pipe should not be less than 120°; you must direct the pipe horizontally, or, alternatively, the pipe should go up from the initial point and should be led to an outer wall.
- After the installation, make sure that the range hood is level to avoid grease collection at one end.
- Ensure the expansion pipe selected for installation complies with relevant standards and is fire retardant

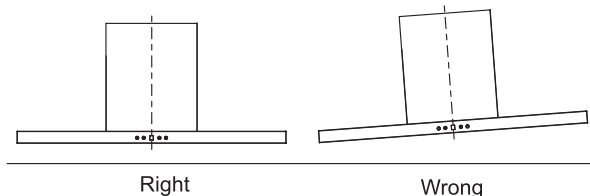

WARNING:



- For safety reason, please use only the same size of fixing or mounting screws which are recommended in this instruction manual.
- Failure to install the screws or fixing device in accordance with these instructions may result in electrical hazards.

Start Using Your range hood

Touch control with LED display



Timer

Lamp

Speed

Power

1. Press the “Power” button, the button control the “on” & “off” of the hood.
2. Press the button “Speed” time after time, the motor runs as low / mid / high / low / mid..., the speed runs circularly; and the LED display will indicate as 1-2-3-1-2... circularly.
3. Press “Lamp” button, the light is on, press this button again, the light is off. Please note the Lamp is not under control of the on/off button.
4. When the hood is working, if press the “Timer” button, the hood will go into the status of acquiescent working (acquiescent time is 9mins), and then, LED display will be shown 9.8.7.6 ...decreasing by 1,when time is up, the hood will be off automatically and the lamp will extinguish. If pressing “Timer” button, the hood will go in or go out “Timer” function.

TROUBLESHOOTING

Fault	Possible Cause	Solution
Light on, but motor does not work	Fan switch turned off	Select a fan switch position.
	Fan switch failed	Contact service center.
	Motor failed	Contact service center.
Light does not work, motor does not work	House fuses blown	Reset/Replace fuses.
	Mains power cable is loose or disconnected	Refit mains power cable to power outlet. Switch power outlet on.
Oil leakage	Leakage from the connection of chimney and cover	Take chimney down and seal.
Lights not working	Broken or faulty bulbs	Replace bulbs as per this instruction.
Insufficient suction	The distance between the range hood and the gas top is too far	Refit the range hood to the correct distance.
The range hood inclines	The fixing screw is not tight enough	Tighten the hanging screw and make it horizontal.

NOTE:



Any electrical repairs to this range hood must conform to your local, state laws. Please contact the service centre if in any doubt before undertaking any of the above. Always disconnect the unit from the power source when opening the unit.

MAINTENANCE AND CLEANING

Caution:

- Before maintenance or cleaning is carried out, the range hood should be disconnected from the mains power supply. Ensure that the range hood is switched off at the wall socket and the plug removed.



- External surfaces are susceptible to scratches and abrasions, so follow the cleaning instructions to ensure the best possible result is achieved without damage.

GENERAL

Cleaning and maintenance should be carried out with the range hood cold especially when cleaning. Avoid leaving alkaline or acid substances (lemon juice, vinegar etc.) on the surfaces.

STAINLESS STEEL

The stainless steel must be cleaned regularly (e.g. weekly) to ensure a long life expectancy. Dry with a clean soft cloth. A specialized stainless steel cleaning fluid may be used.

NOTE:

Ensure that wiping is done along with the grain of the stainless steel to prevent any unsightly crisscross scratching patterns from appearing.

CONTROL PANEL SURFACE

The inlay control panel can be cleaned using warm soapy water. Ensure the cloth is clean and well wrung before cleaning. Use a dry soft cloth to remove any excess moisture left after cleaning.

Important

Using neutral detergents and avoid using harsh cleaning chemicals, strong household detergents or products containing abrasives, as this will affect the appearance of the hood and potentially remove any printing of artwork on the control panel and will void manufacturer's warranty.

GREASE MESH FILTERS

The mesh filters can be cleaned by hand. Soak them for about 3 minutes in water with a mild detergent and then brush it gently with a soft brush. Do not apply too much pressure so as to avoid any damage to it. (Leave to dry naturally out of direct sun light)

Filters should be washed separately to crockery and kitchen utensils. It is advisable not to wash filters in a dishwasher as they may discolor.

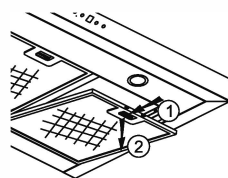

INSTALLING GREASE MESH FILTERS

- To install filters for the following four steps:
 - Angle the filter into the slots at the back of the hood.
 - Push the button on the handle of the filter.
 - Release the handle once the filter fits into a resting position.
 - Repeat to install all filters.

CARBON FILTER-not supplied

Activated carbon filter can be used to trap odors. Normally the activated carbon filter should be changed every 3 to 6 months according to your cooking habits. The installation procedure of activated carbon filter is as below:

1. Before installing or replacing the carbon filters, disconnect the mains power to the unit.
2. Press the filter lock and remove the mesh filter.
3. Turn the carbon filter on both sides of the motor anti-clockwise. Replace the carbon filters with the new carbon filters.
4. Place the mesh filter.
5. Connect the power supply to the wall socket.

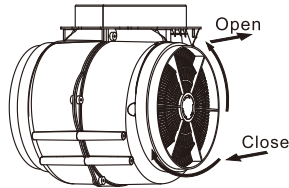

NOTE:

- Make sure the filter is securely locked. Otherwise, it would loosen and cause danger.
- When activated carbon filter attached, the suction power will be lowered.

BULB REPLACEMENT

Important :



- ✧ The bulb must be replaced by the manufacturer, its service agent or similarly qualified persons.
- ✧ Always switch off the electricity supply before carrying out any operations on the range hood. When handling bulb, make sure it has completely cooled down before any direct contact with hands.
- ✧ When handling bulbs hold with a cloth or gloves to ensure perspiration does not come in contact with the bulb as this can reduce the life of the bulb.

Note:

- Before changing the lights, make sure that the range hood is turned off and unplugged.
- Protect against danger when changing lights, such as wearing gloves.

Changing the lights:

- Remove the grease filter.
 - Way 1. Use a tool or the hand to press the spring splinter of both sides of LED light to the inside, until the light is pressed out, see pic 1. Then slightly pull the light connecting wire out, and dismantle the terminal of the light connecting wire. See pic 2.
 - Way 2. Use straight screwdriver to prize up the LED light bottom edge, see pic 3, then slightly pull out the LED light and light connecting wire. See pic 2.
 - Apply the reverse procedure to install the light back.
- ILCOS D code for this lamp is: DSS-1.5/65-S-120/33
 - LED modules –rectangle lamp
 - Max wattage: $2 \times 1.5 \text{ W}$
 - Voltage range: DC 12V
 - Dimensions:

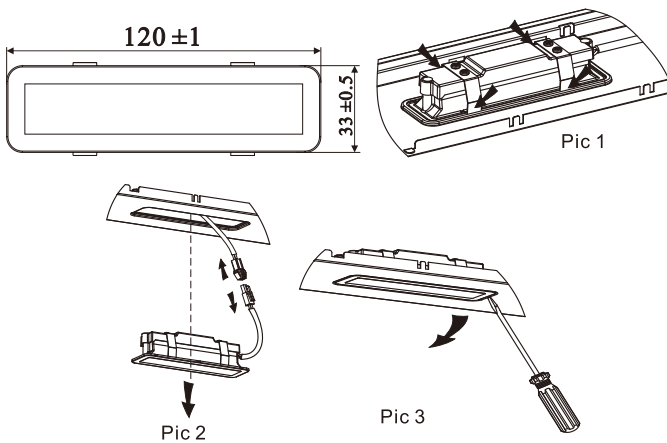

ENVIRONMENTAL PROTECTION:



This product is marked with the symbol on the selective sorting of waste electronic equipment. This means that this product must not be disposed of with household waste but must be supported by a system of selective collection in accordance with Directive 2012/19/EU. It will then be recycled or dismantled to minimize impacts on the environment, electrical and electronic products are potentially dangerous for the environment and human health due to the presence of hazardous substances. For more information, please contact your local or regional authorities.

NOTE:

The following shows how to reduce total environmental impact (e.g. energy use) of the cooking process.

- (1) Install the range hood in a proper place where there is efficient ventilation.
- (2) Clean the range hood regularly so as not to block the airway.
- (3) Remember to switch off the range hood light after cooking.
- (4) Remember to switch off the range hood after cooking.

INFORMATION FOR DISMANTLING

Do not dismantle the range hood in a way which is not shown in the user manual. The range hood could not be dismantled by user. At the end of life, the range hood should not be disposed of with household waste. Check with your Local Authority or retailer for recycling advice.

AWARD APPLIANCES (NZ) LTD

WARRANTY STATEMENT

Please complete the following details when you unpack the product and retain this card with the purchase invoice or sales docket. Verification of the date of purchase will be required should service under the warranty be sought.

Model Number
Date of Purchase
Retailers / Dealers Name

WARRANTY

This product is covered by a Warranty in addition to all rights available to you by statute. The Warranty is for a period of **twenty-four (24) months** from the date of purchase, subject to the conditions below. Registering your appliance online at www.awardappliances.co.nz will qualify your purchase for an **additional twelve (12) months warranty cover on parts only**.

The Warranty covers rectifications of faults arising from defective materials, components, faulty workmanship or assembly. The product will be repaired or replaced at the sole discretion of Award Appliances (NZ) Ltd.

Conditions of Warranty:

1. The purchaser/installer carefully follows the installation instructions provided and complies with electrical, gas, plumbing, building and other regulations and codes of practice in New Zealand;
2. That the purchaser carefully follows the instructions provided in the owner's handbook relating to the proper use and care of the product;
3. The product is not used for any purpose other than the domestic use for which it has been designed. Use for commercial purposes or any application outside of a residential dwelling, shall reduce the warranty period to three (3) months from date of purchase.
4. That the product was purchased and installed in the North or South Islands of New Zealand

This Warranty does not extend to:

- (a) Lamps/LED, filters, blockages/restrictions, incorrect detergents, incorrect or poor installations, incorrect use.
- (b) Back feeding from waste disposal units, vermin/insect damage or transit protection left installed.
- (c) Damage to surface coatings caused by cleaning or maintenance using products not recommended by the manufacturer; tin foil on oven base, leaving a baking sheet or tray on oven base.
- (d) Defects caused by normal wear and tear, accident, negligence, alteration or misuse.
- (e) Damage caused by spill-overs, lack of maintenance, or impact.
- (f) Damage or faults caused by incorrect power supply, power surges or storm damage.
- (g) Any damage or fault arising from installation of the product.
- (h) A product dismantled, repaired or serviced by any person other than an authorised employee or service agent as appointed by Award Appliances (NZ) Ltd.
- (i) Any additional travelling costs beyond 30km from an appointed service agent.

If you are unable to establish the date of purchase, or the fault is not covered by this Warranty, or if the product is found to be in working order, you will be required to bear all service charges. Please present this notice to the service person, together with proof of purchase. The warranty is non-transferable.

For service please telephone (03) 348 0556

AWARD APPLIANCES (NZ) Ltd
382 Blenheim Road CHRISTCHURCH
Telephone: (03) 348 0556 Email: service@award.co.nz
www.awardappliances.co.nz